



CSCI 150

Introduction to Digital and Computer System Design

Lecture 4: Sequential Circuit VI



Jetic Gū
2020 Winter Semester (S1)

Overview

- Focus: Basic Information Retaining Blocks
- Architecture: Sequential Circuit
- Textbook v4: Ch5 5.7; v5: Ch4 4.6
- Core Ideas:
 1. State Machine Diagrams: Moore model

State Diagram

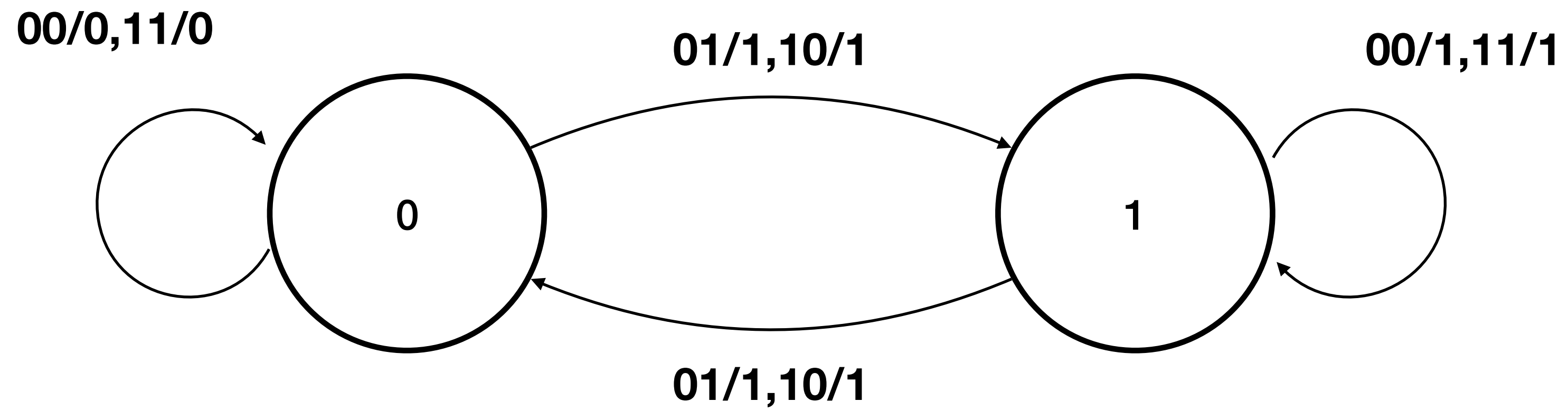

State Diagram

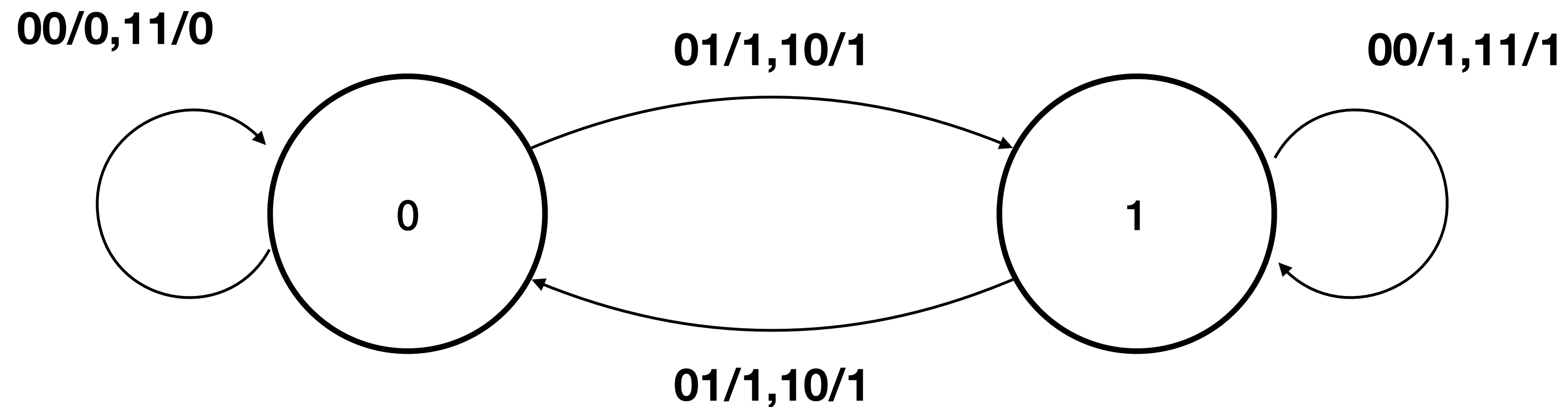

Mealy machine: a finite-state machine whose output values are determined both by its current state and the current inputs

State Diagram

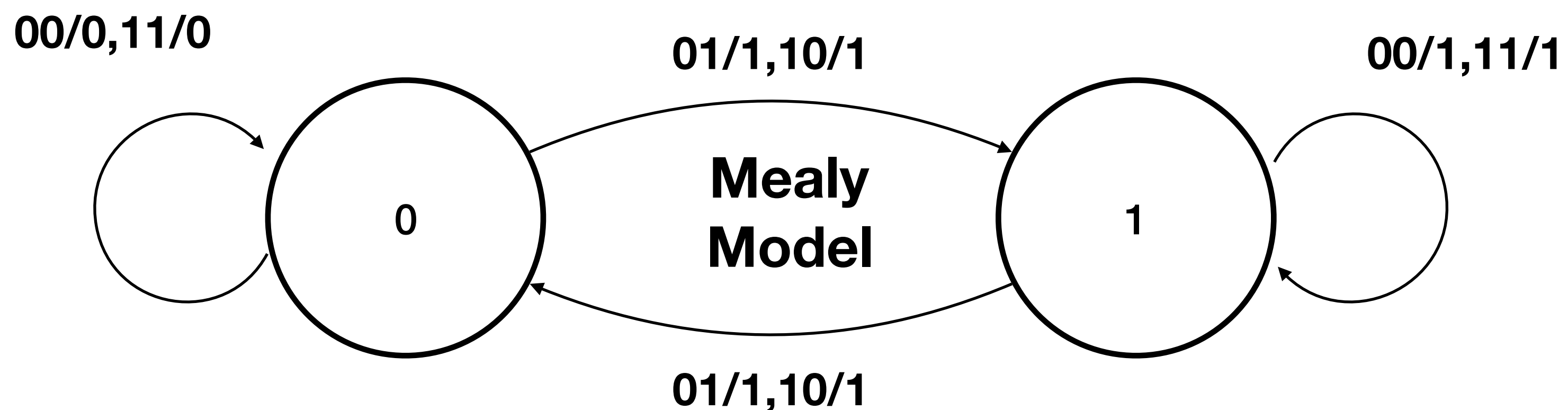

Mealy machine: a finite-state machine whose output values are determined both by its current state and the current inputs

State Diagram

- Modelling state transitions in a visual way
- Problems with Mealy Model
 - Inefficient when input and output contain too many bits
all 2^n inputs and m -bit outputs must be written down for each transition
 - Unworkable for larger designs

State Machine Diagrams

Moore Model

Improvements over Mealy

- Called Moore, the name sounds better (also State-Machine Diagram)
- Conditions
 - Input Condition: Boolean expressions or equations
Also called **transition condition (TC)**, causes transition when its value is 1
 - **Output Condition (OC)**: Boolean expressions or equations
Causes specific output when its value is 1

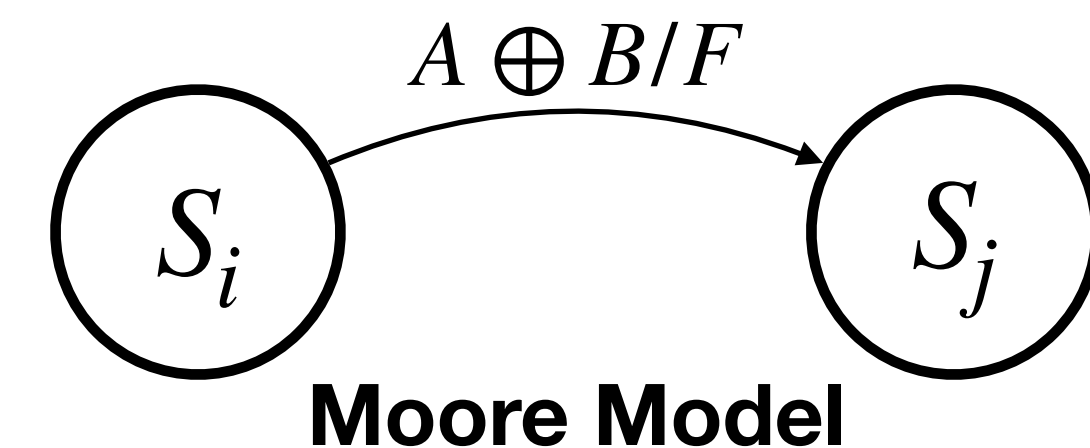
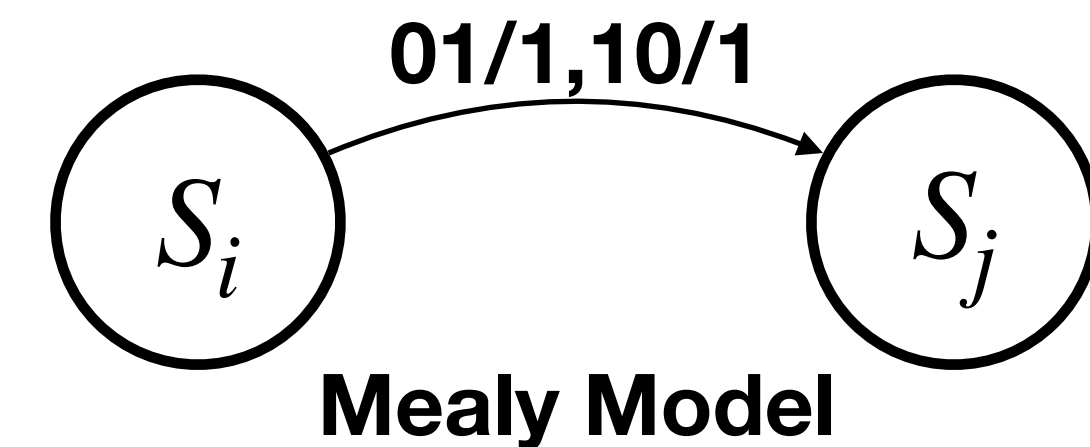

Transition Conditions

- Associated with transitions
- Performs transition when condition is met
- Validity
Must not be conflicting conditions
i.e. only one TC can be true for any given input

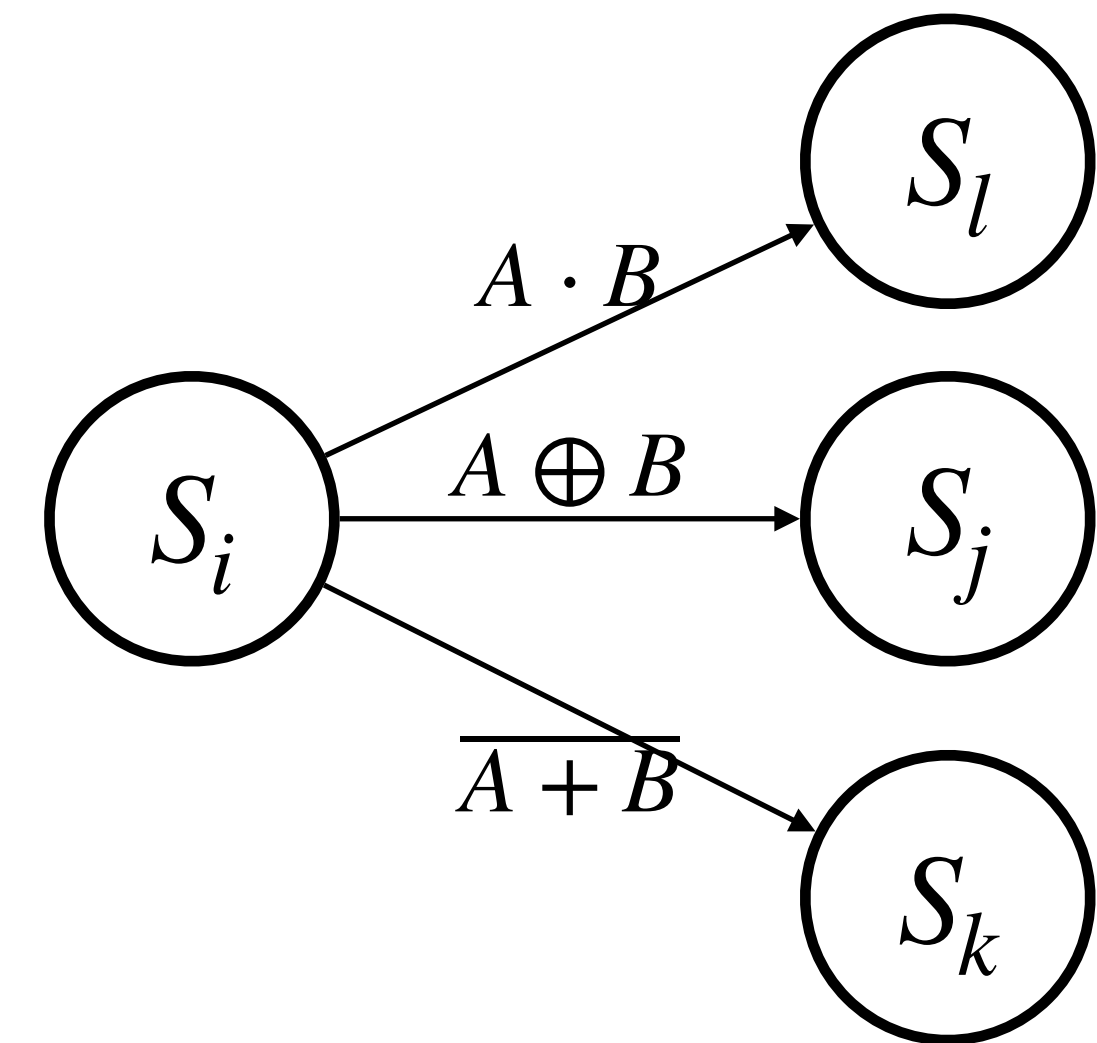

Transition Conditions

- Invalid TC
 - Condition \bar{A} and \bar{B} can be met at the same time
- Check all transitions from each state of invalid TC

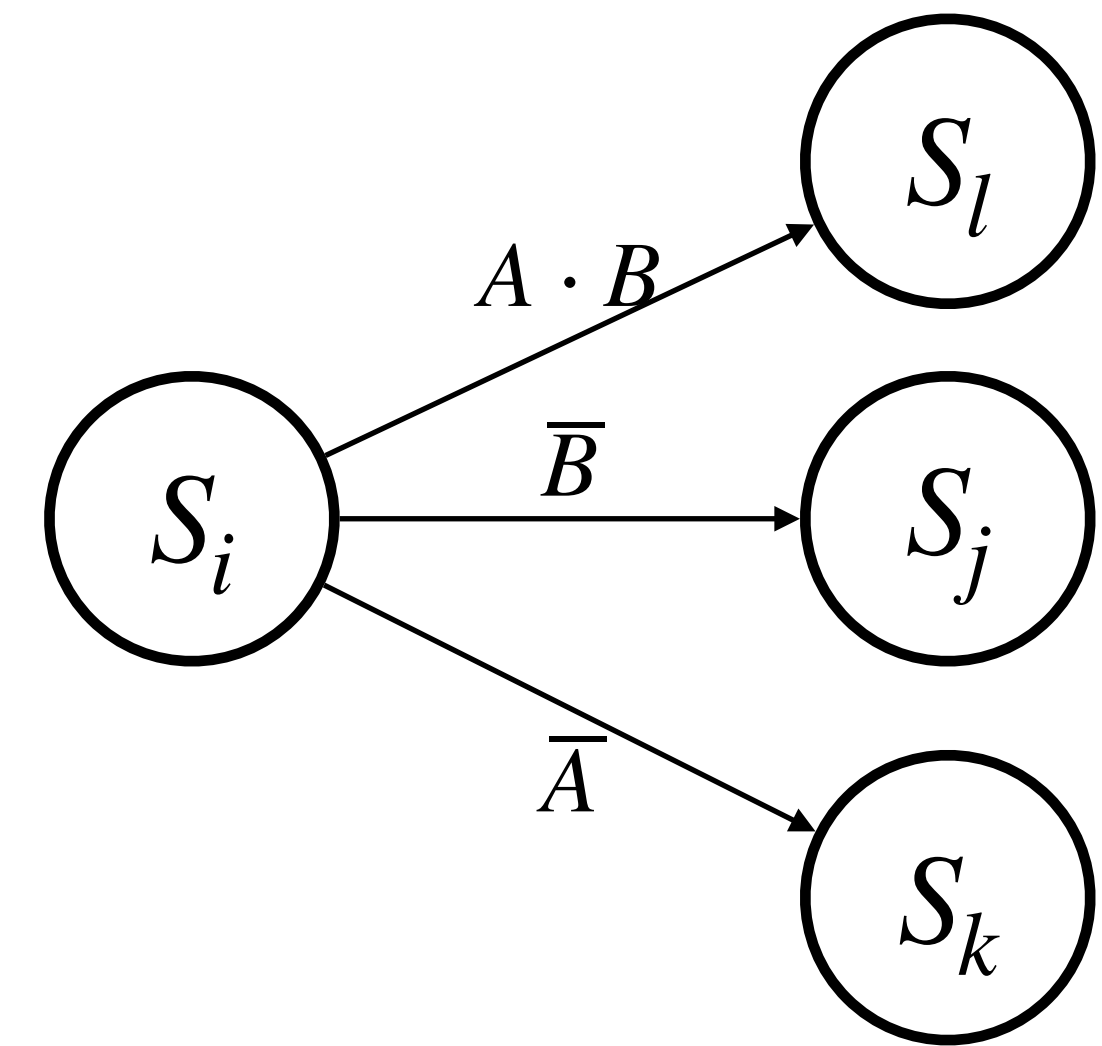

Output Conditions

Defaults: $Y = 0, Z = 0$

- Associated with transitions/states
- For associated transition/state, outputs when condition is met
- Default: output values unless otherwise specified
- Validity
Must not be conflicting conditions
i.e. only one OC can be true for any given input/state

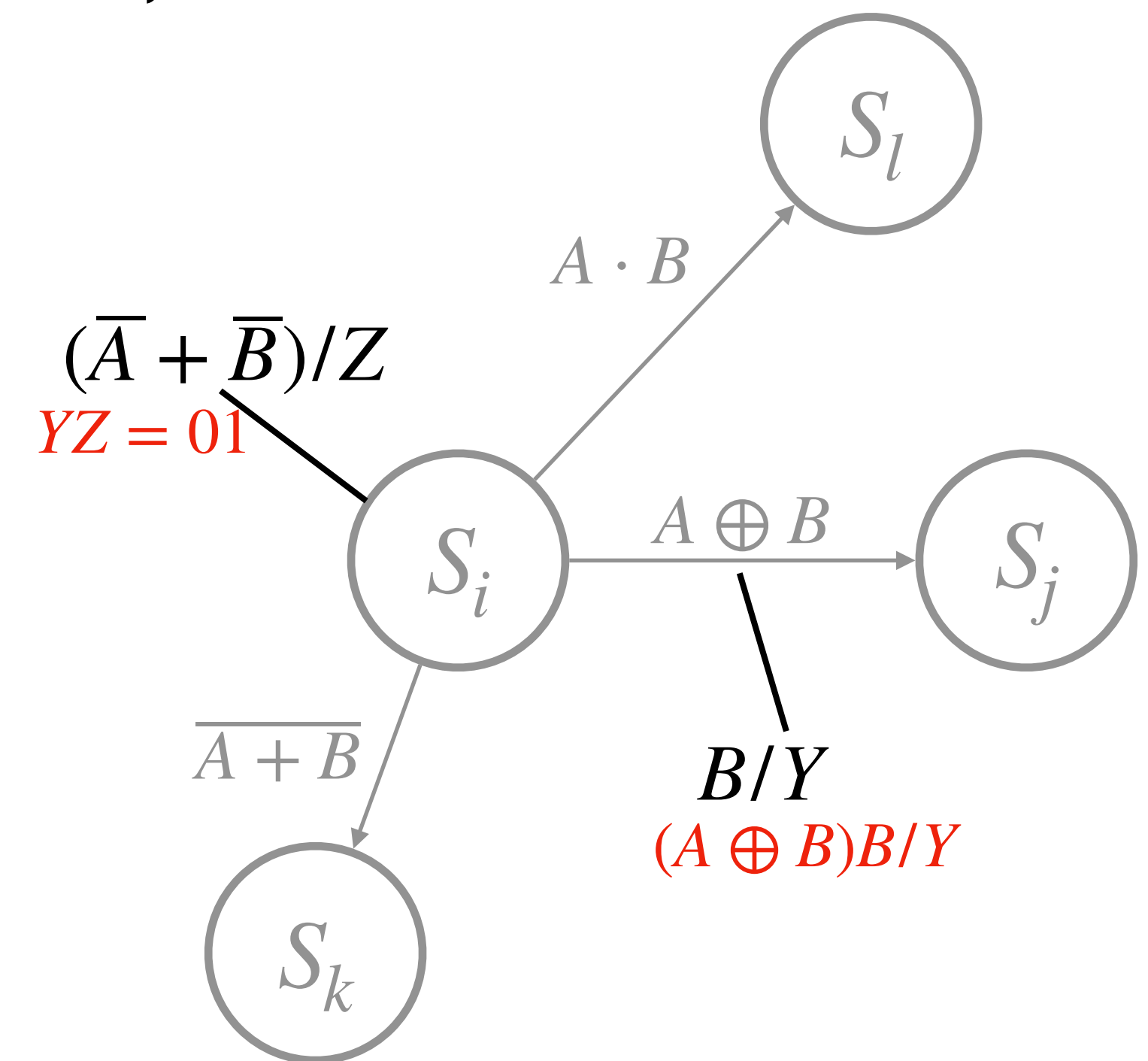

Output Conditions

Defaults: $Y = 0, Z = 0$

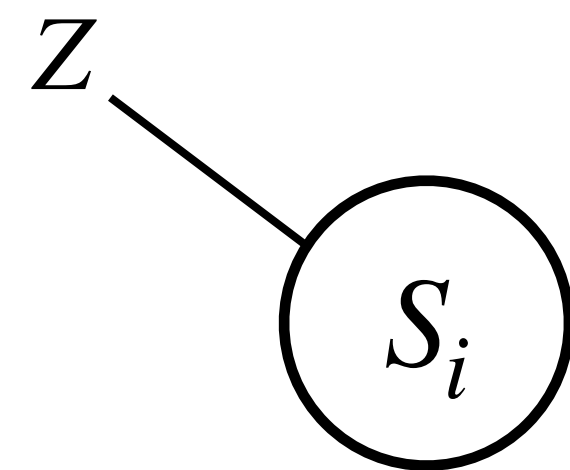

Always output 01 at state S_i

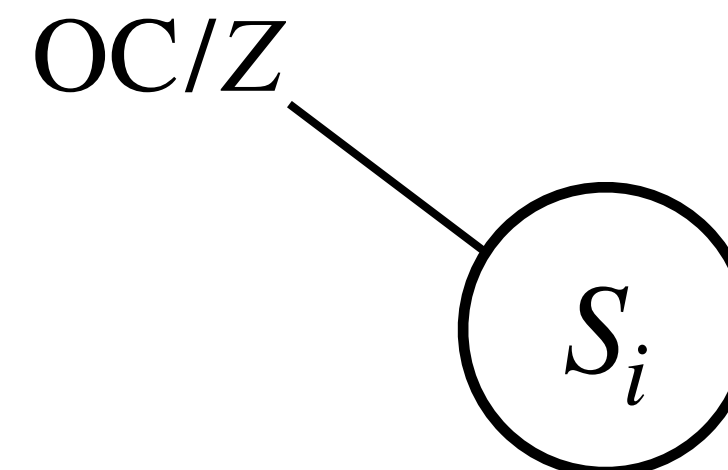

Output 01 when condition OC is met at S_i

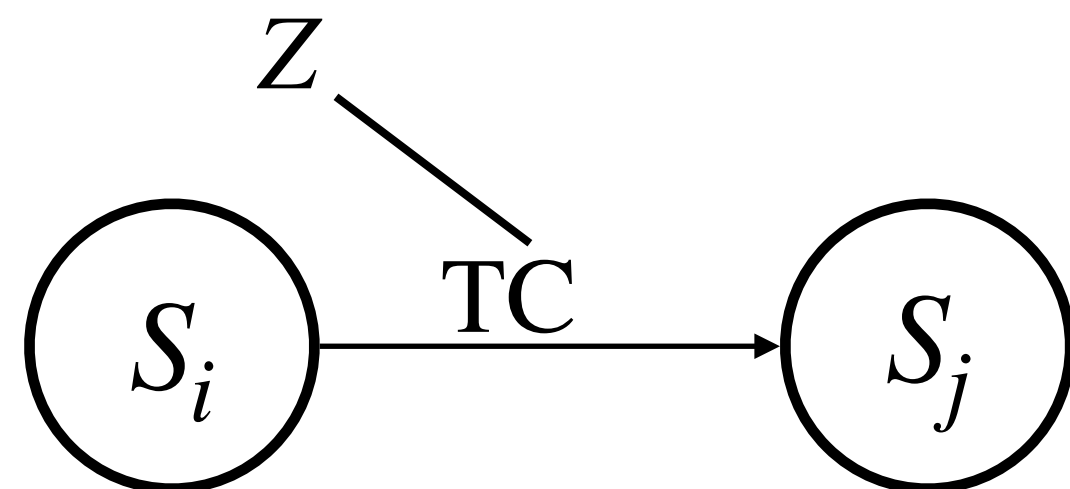

Always output 01 at state S_i ,
when input meets TC

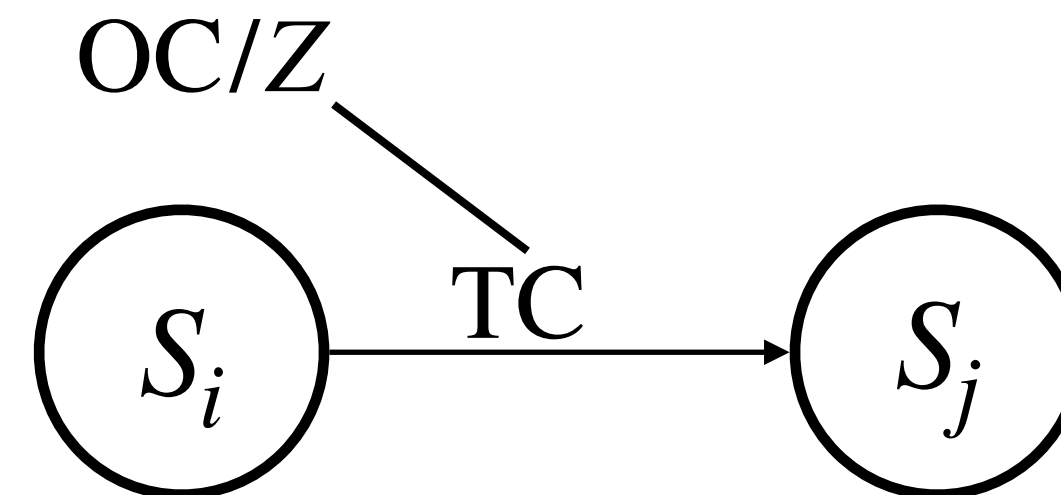

Output 01 when condition OC is met at S_i ,
and input meets TC

Output Conditions

- Invalid OC
 - Condition \bar{A} and \bar{B} can be met at the same time
- Check all transitions from each state of invalid OC

From Mealy to Moore

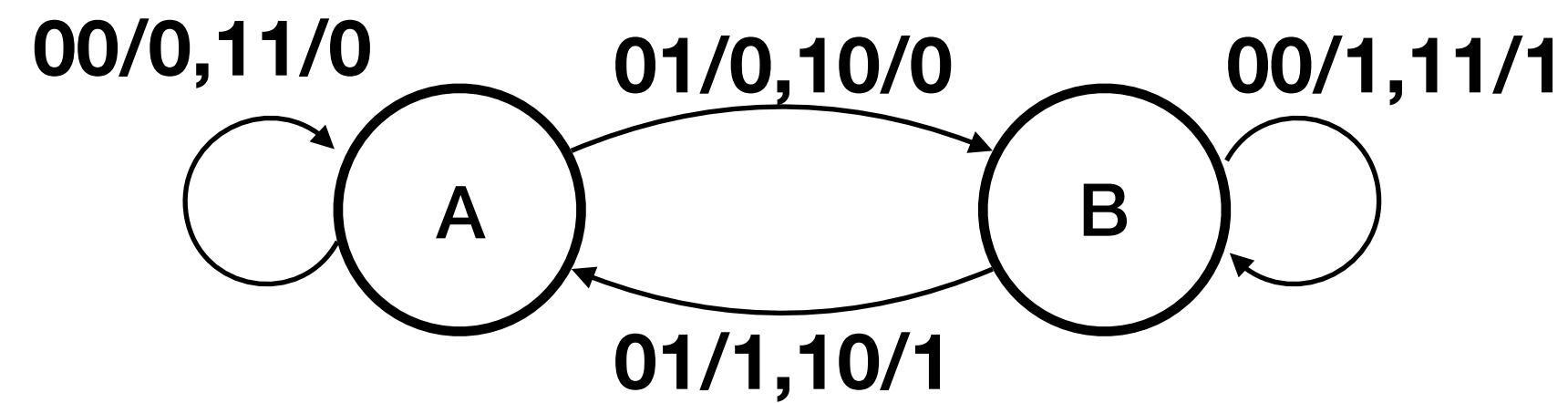

1. Preserve arcs
2. Do the TCs
3. Do the OCs

From Mealy to Moore

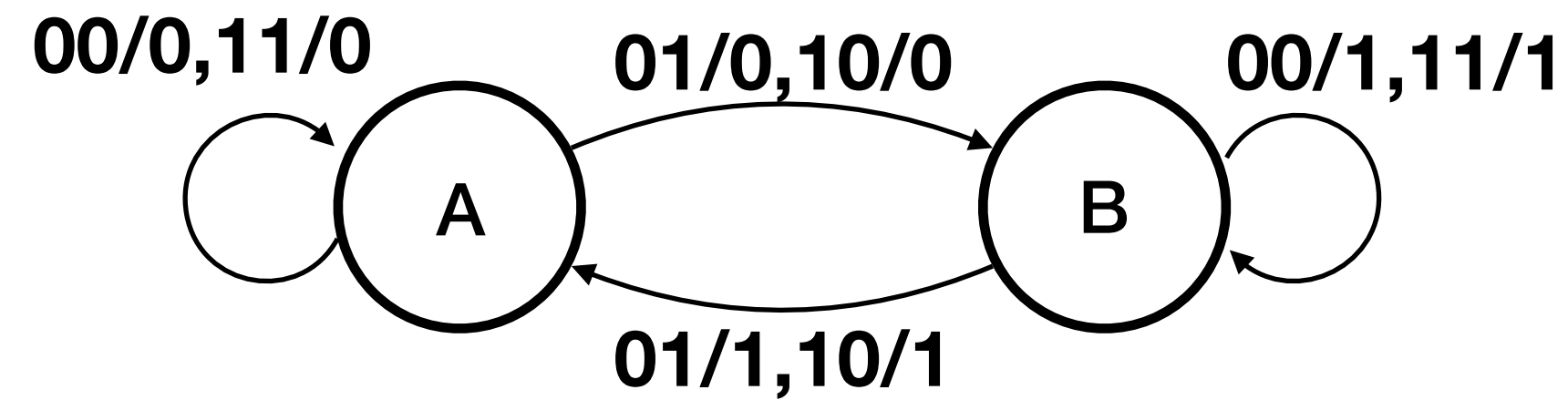

1. Preserve arcs
2. Do the TCs
3. Do the OCs

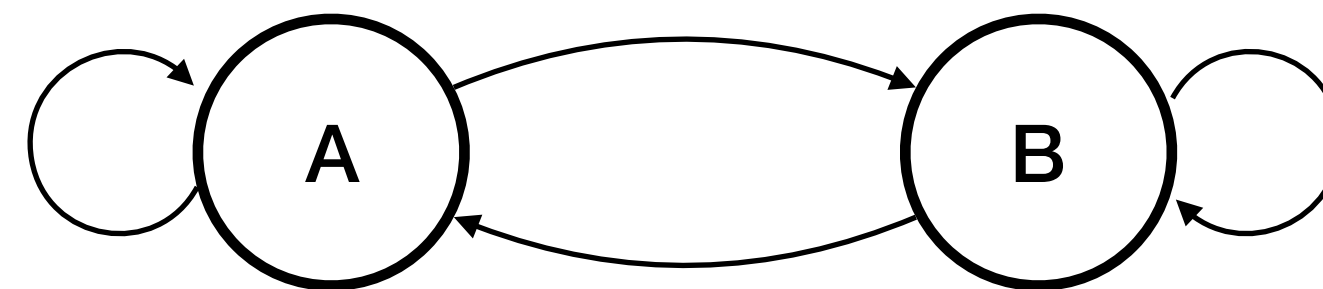

From Mealy to Moore

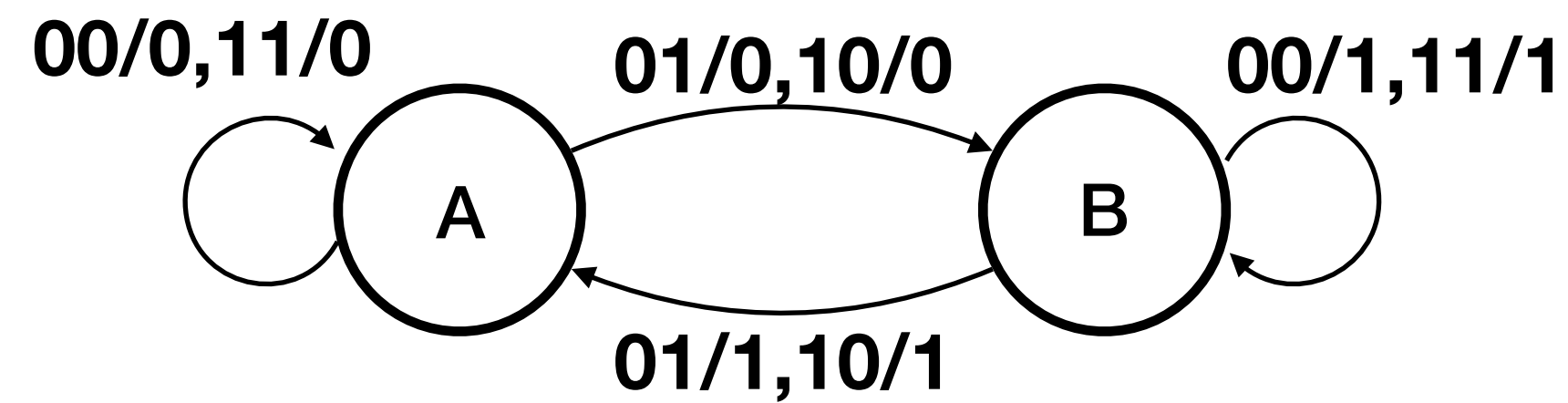

1. Preserve arcs
2. Do the TCs
3. Do the OCs

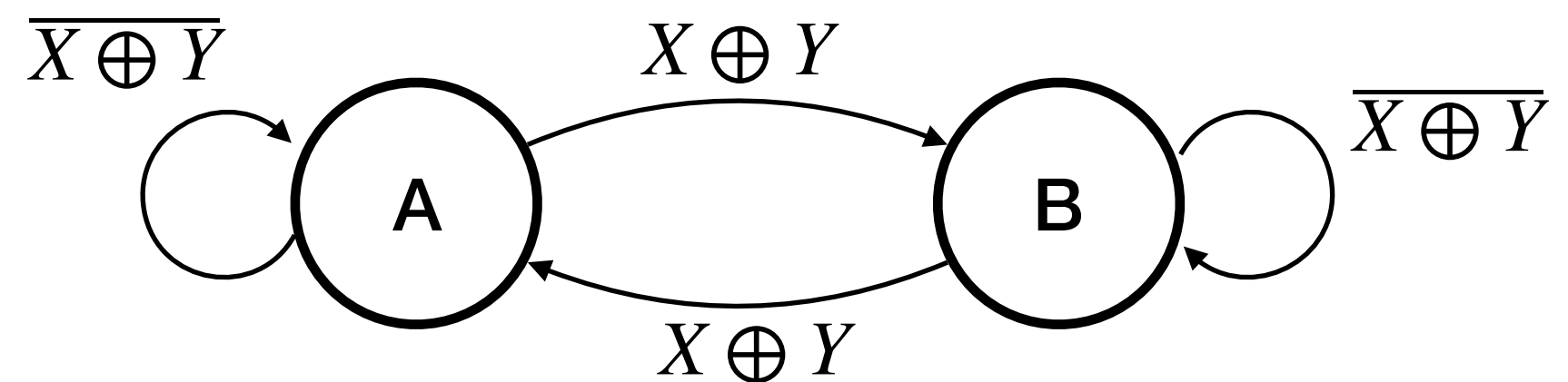

From Mealy to Moore

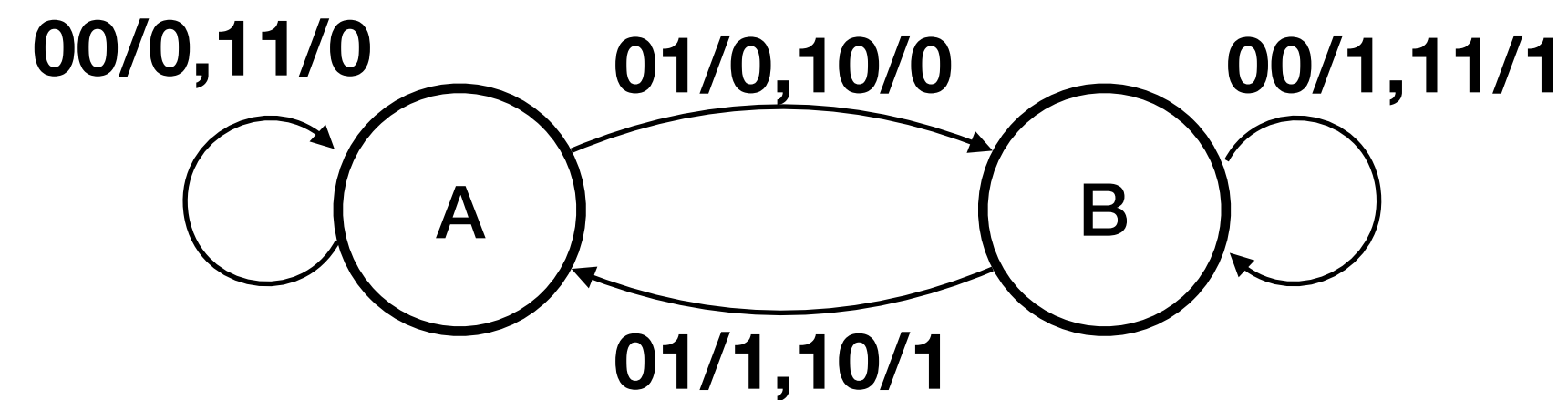

1. Preserve arcs
2. Do the TCs
3. Do the OCs

Default output: $F = 0$

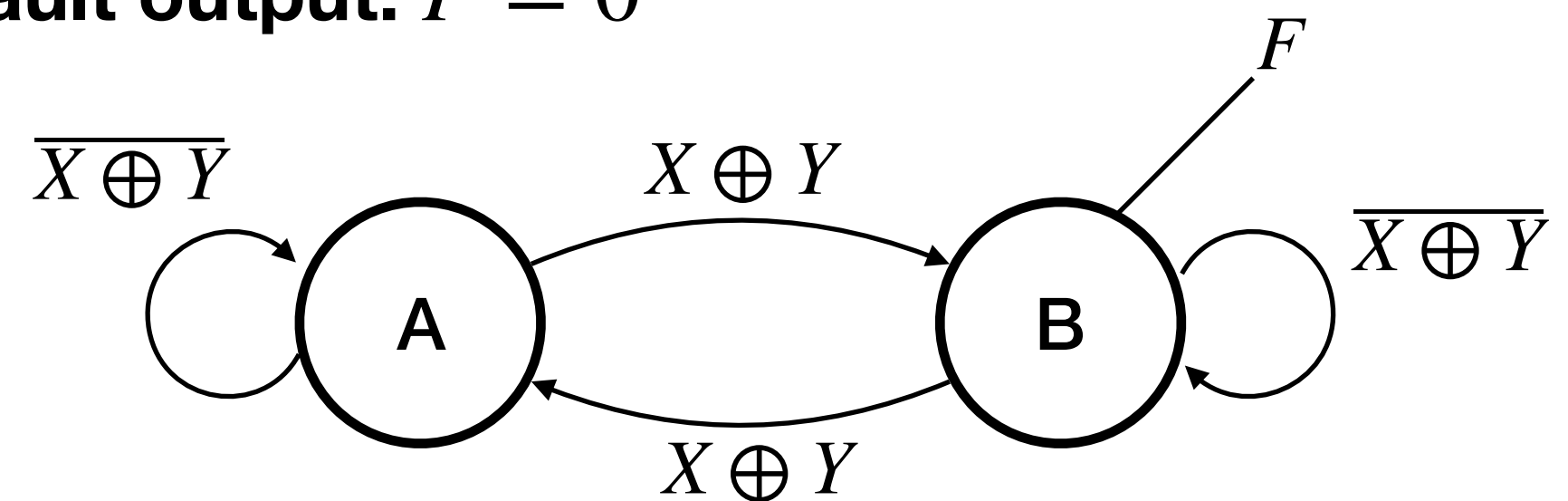

From State Table to Moore

State Table

Present State		X	Next State		F
A	B		A	B	
0	0	0	0	0	0
0	0	1	0	1	0
0	1	0	1	0	1
0	1	1	1	0	1
1	0	0	1	0	0
1	0	1	1	1	0
1	1	0	0	0	0
1	1	1	0	0	0

From State Table to Moore

State Table

Present State		X	Next State		F
A	B		A	B	
0	0	0	0	0	0
0	0	1	0	1	0
0	1	0	1	0	1
0	1	1	1	0	1
1	0	0	1	0	0
1	0	1	1	1	0
1	1	0	0	0	0
1	1	1	0	0	0

Input: X

Output: F

Default: $F = 0$

Exercise

From State Table to Moore

State Table

Present State		X	Next State		F
A	B		A	B	
0	0	0	0	0	0
0	0	1	0	1	0
0	1	0	1	0	1
0	1	1	1	0	1
1	0	0	1	0	0
1	0	1	1	1	0
1	1	0	0	0	0
1	1	1	0	0	0

Input: X

Output: F

Default: $F = 0$

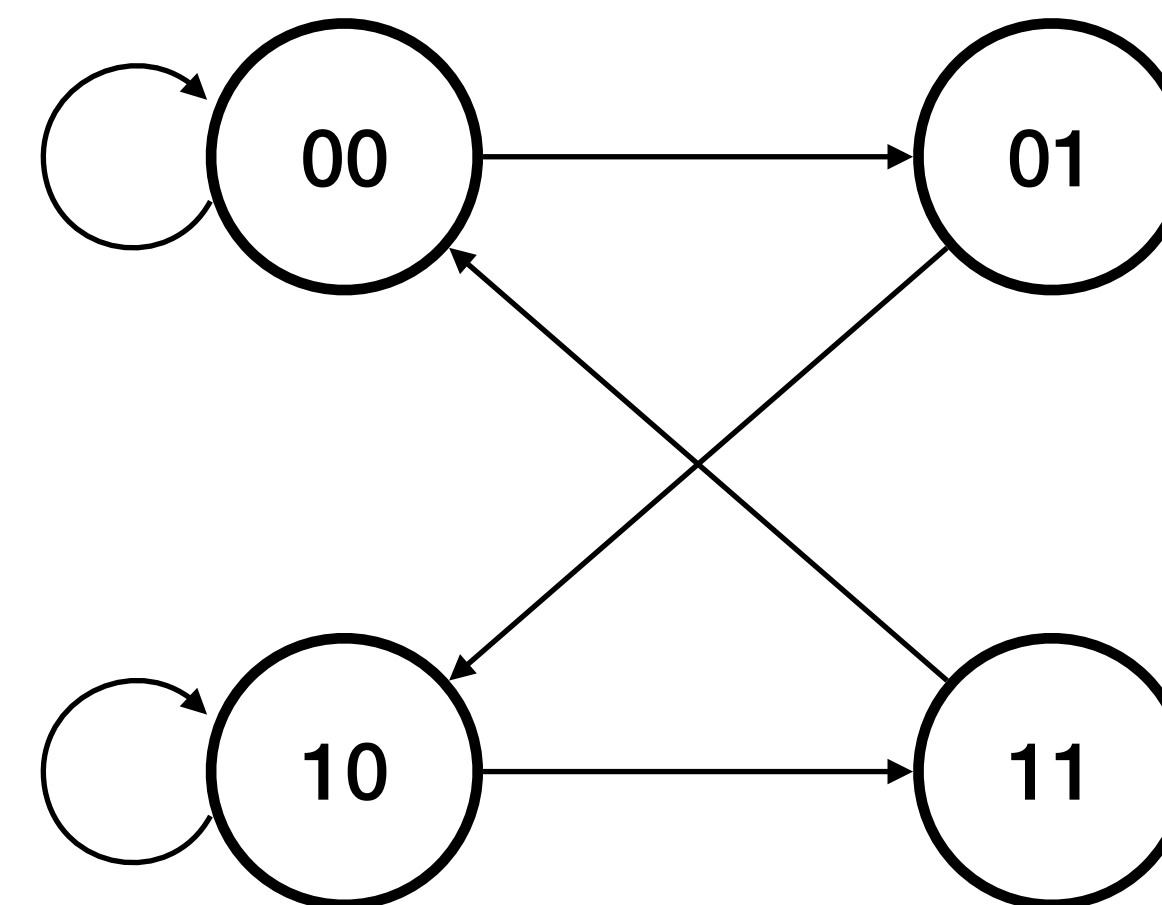

From State Table to Moore

State Table

Present State		X	Next State		F
A	B		A	B	
0	0	0	0	0	0
0	0	1	0	1	0
0	1	0	1	0	1
0	1	1	1	0	1
1	0	0	1	0	0
1	0	1	1	1	0
1	1	0	0	0	0
1	1	1	0	0	0

Input: X

Output: F

Default: $F = 0$

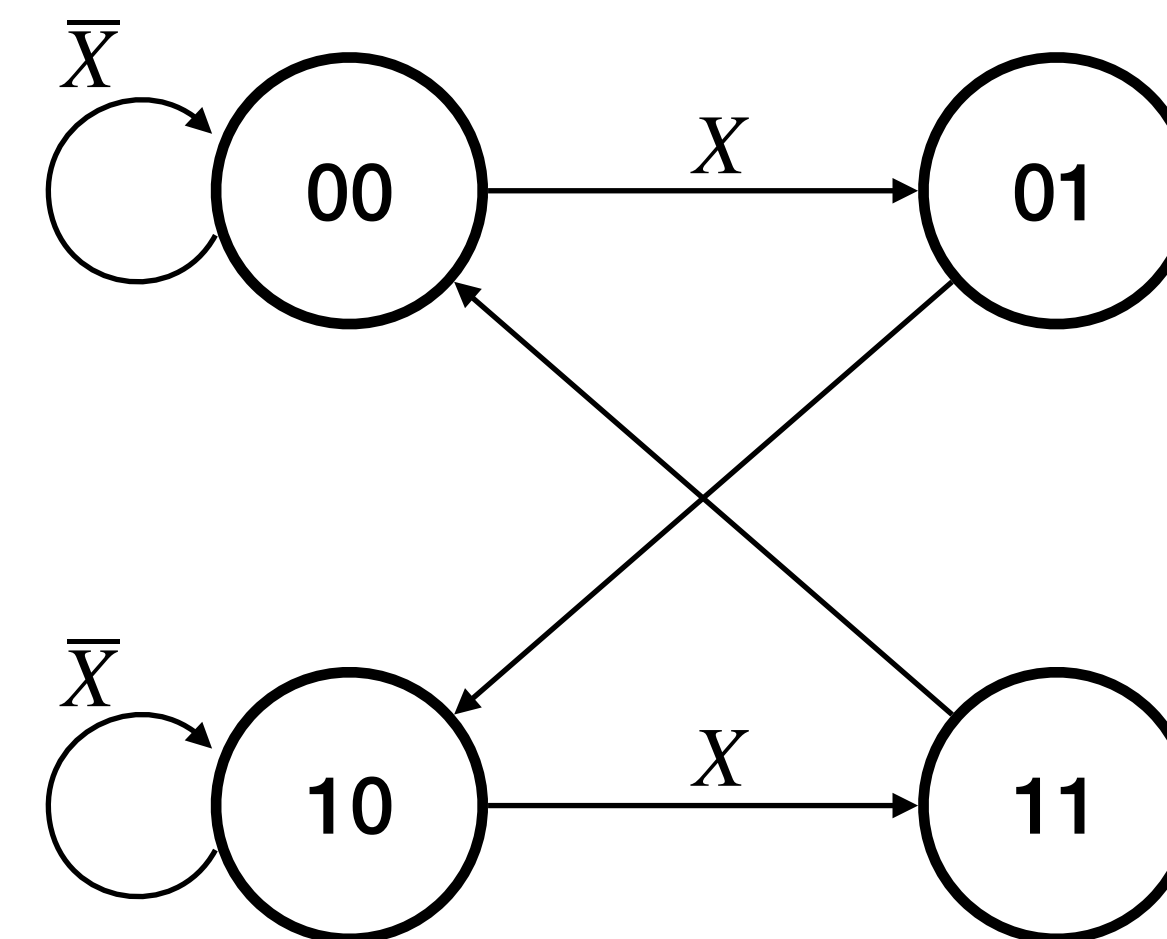

From State Table to Moore

State Table

Present State		X	Next State		F
A	B		A	B	
0	0	0	0	0	0
0	0	1	0	1	0
0	1	0	1	0	1
0	1	1	1	0	1
1	0	0	1	0	0
1	0	1	1	1	0
1	1	0	0	0	0
1	1	1	0	0	0

Input: X

Output: F

Default: $F = 0$

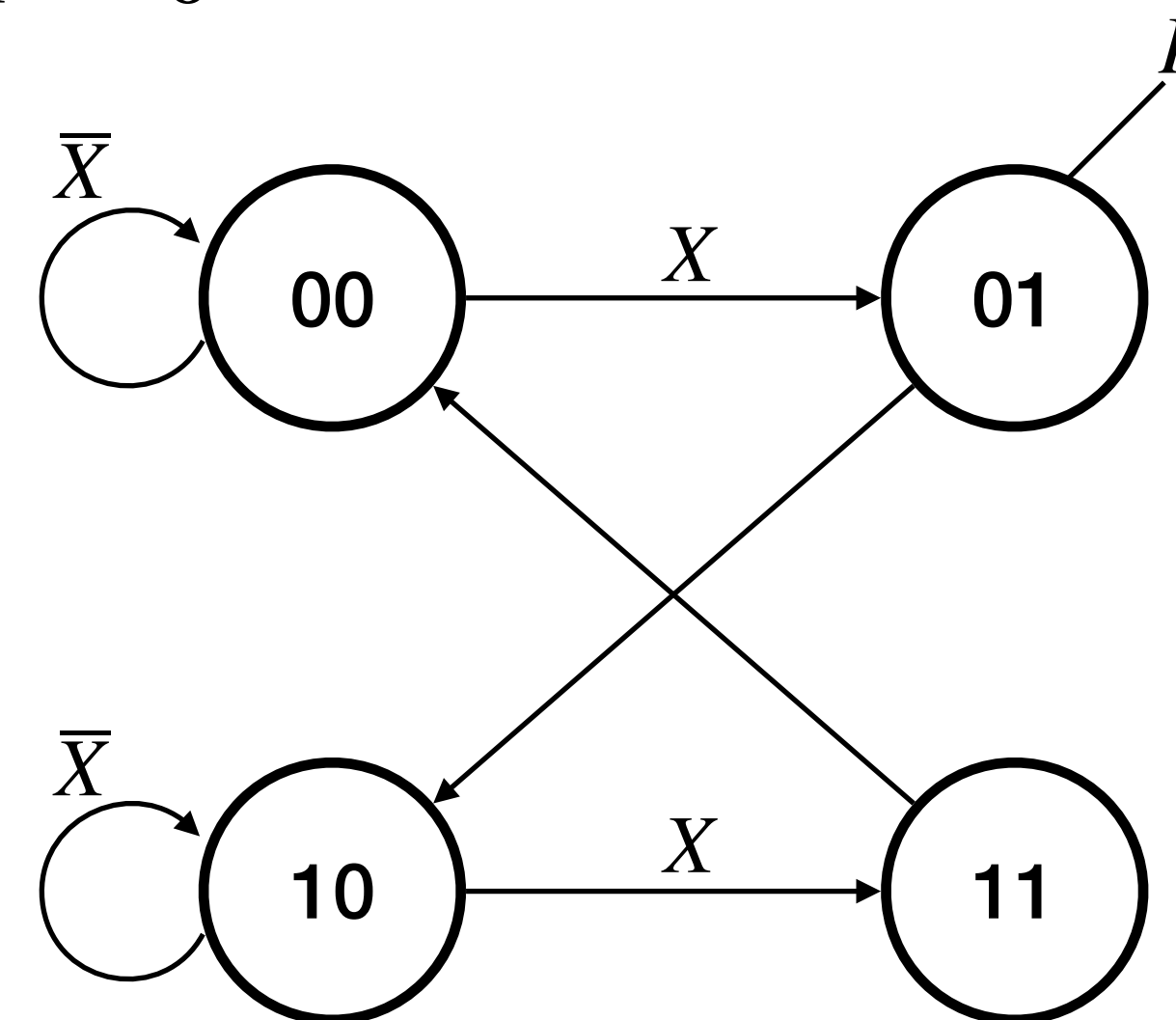

From Mealy to Moore

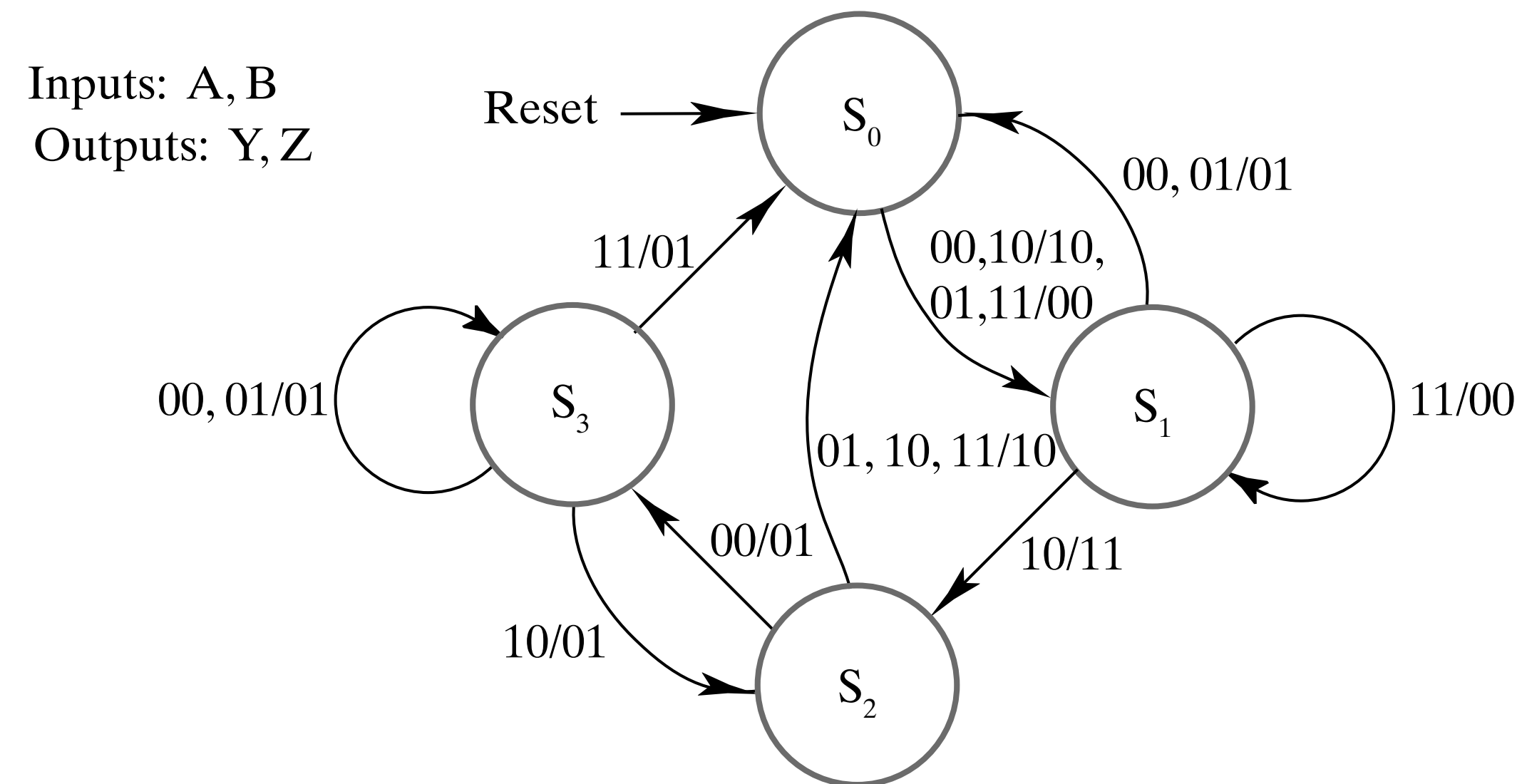

From Mealy to Moore

Inputs: A, B
Outputs: Y, Z

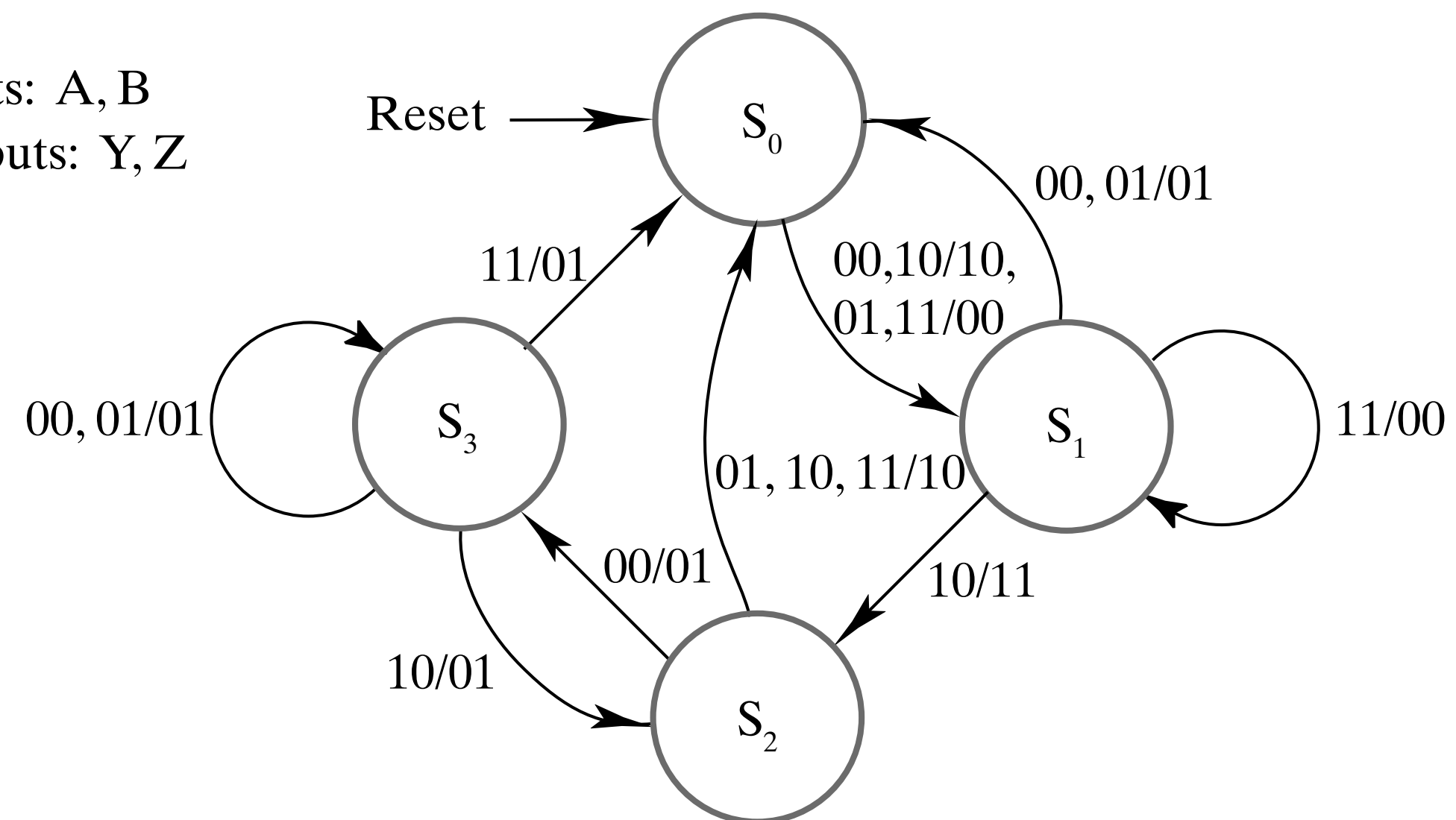

Inputs: A, B
Outputs: Y, Z
Defaults: Y = 0, Z = 0

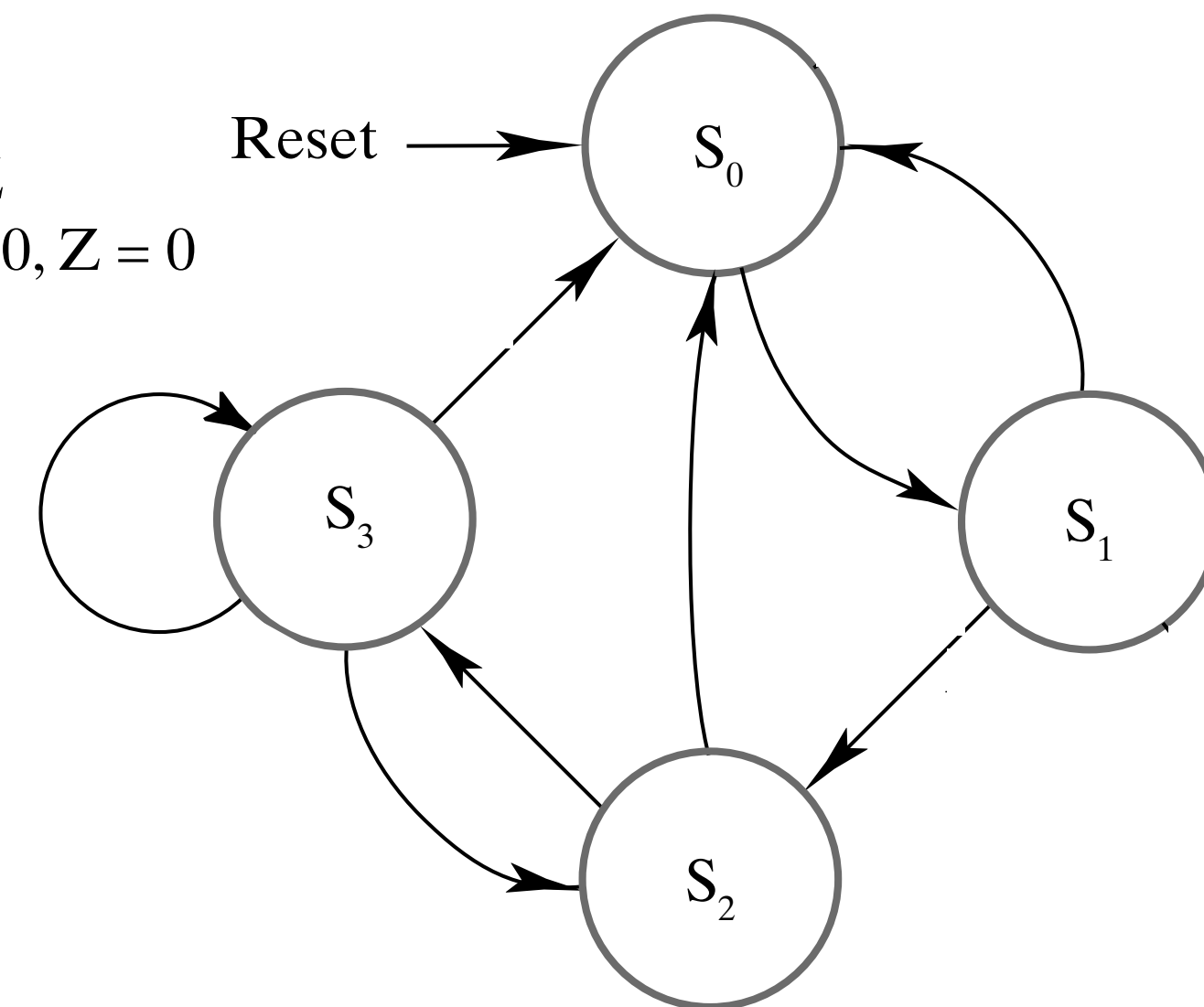

From Mealy to Moore

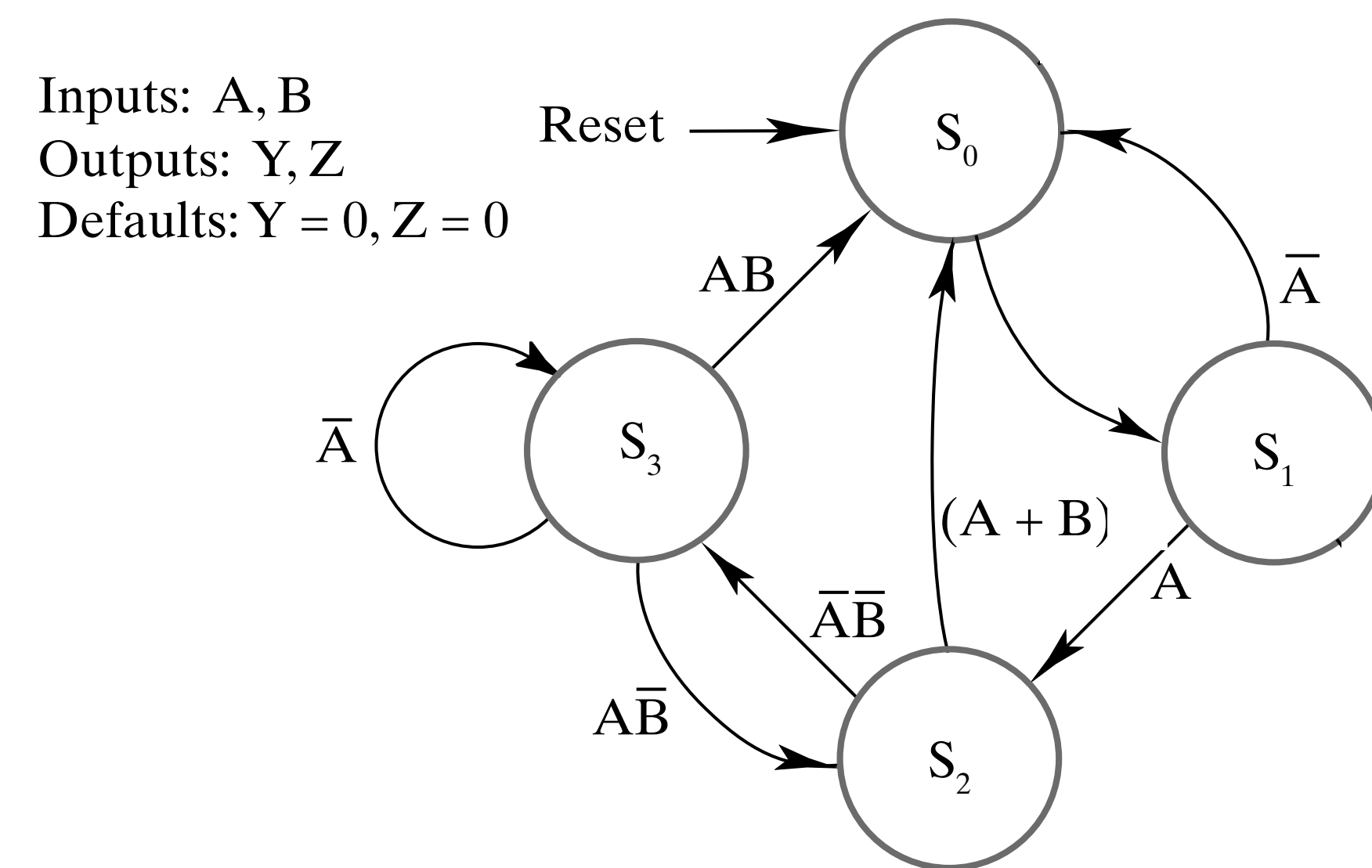
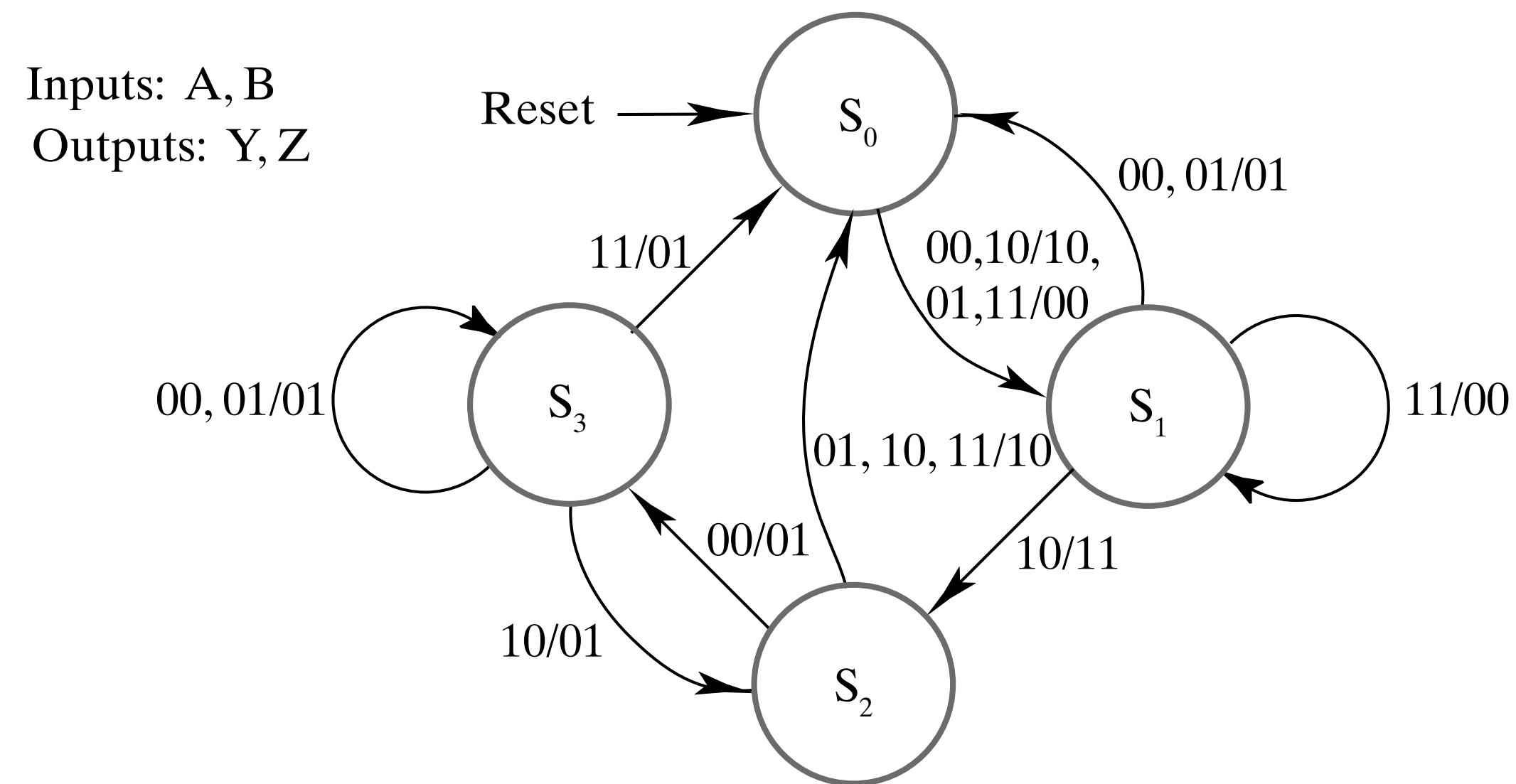

From Mealy to Moore

Inputs: A, B
Outputs: Y, Z

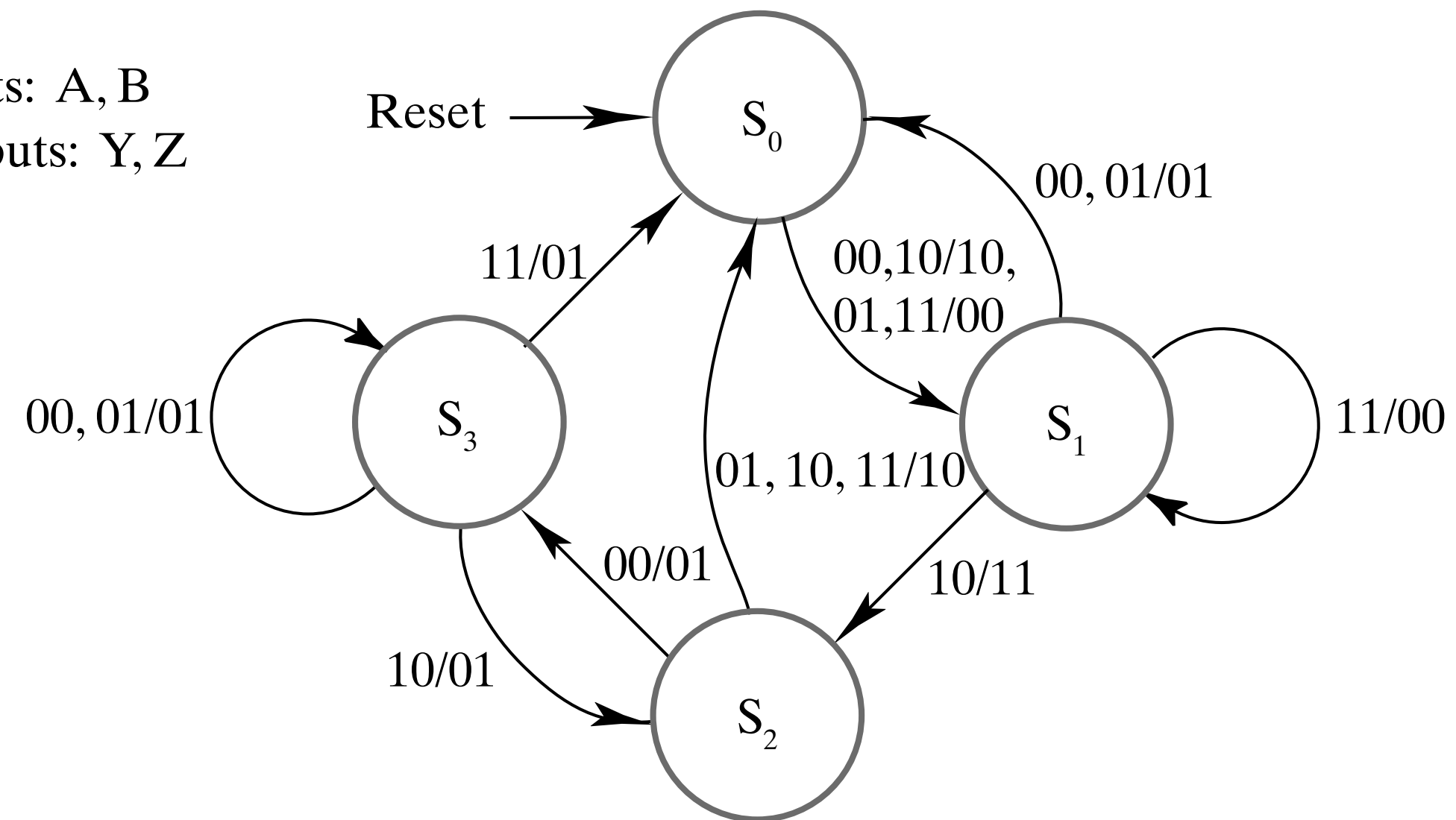

Inputs: A, B
Outputs: Y, Z
Defaults: $Y = 0, Z = 0$

